

VELOX 41320-W-2.4-8 and 41321-W-2.4-8

EN54-3&23 Approved Loop Powered Addressable
indoor/weatherproof wall mounted Sounder Beacon



At a Glance

The 4132X EN54 part 3 & 23 approved sounder beacon is part of the VELOX 41000 family of products. The VELOX 41000 Addressable range of Sounder Beacons with state-of-the-art microprocessor-controlled technology, are fully loop powered from the range of VELOX fire alarm control panels. The new range of 4132X devices are fully addressable by VELOX range of control panels, provided with in-built isolators to enhance reliability.

The new 4132X range of devices approved to EN54-3, EN54-23 and EN54-17.

The Loop Powered devices of the 4132X series can be connected and powered from the VELOX 2Km loop length using 1.5mm² cable. All the 41000 range of devices are loop powered, which means cost effective wiring, and easy to install on the same fire detection loop. This exceptional feature shall drop the cost dramatically, especially in an application like Hotels and Malls where many beacons or sounder-beacons are required to be installed on the same fire alarm loop.

5 Years Warranty

The VELOX clients enjoy five years warranty on all the VELOX devices. An extra added advantages when installing the VELOX range of products.

Features

- Powered from the same fire detection loop
- Automatic or Manual Addressing functions.
- Built-in Short Circuit Isolator and EN54-17 certified.
- EN54-3 and EN54 part 23 approved.
- High-Intensity White Flash
- 0.5Hz and 0.1 Hz flash rate available via the DIP switch
- 32 tones plus a selectable override tone
- Deep-Base IP65 versions
- Features base locking system as standard
- Unique twist and lock bayonet mounting system

Approvals & Standards

The Velox 4132X sounder-beacons comply with the following British and European standards. BS EN 54-3, EN54-23 and EN54-17.

Commissioning is never easier

VELOX wants to make it easy for the installer, neither dip or rotary switches are required to address the devices, nor barcode scanners or other complicated methods of installation are needed.

Automatic addressing is an added benefit to the many others of VELOX technology, where the fire alarm control panel sequentially addresses each device and makes sure that no duplicate addresses are allowed. Furthermore, when needed to assign an address in a non-sequential fashion, the manual programming via the VELOX detector programming tool is utilised.

Applications

The VELOX 41320 and 41321 series of loop powered addressable Sounder Beacon are designed to fit broad range applications such as hotel rooms, corridors, malls, carpark, electrical rooms. The vast variety of 32 tones that complies with worldwide requirements of sound tones makes these devices suitable for use worldwide.

The sounder activated by a specific command sent from the fire alarm control panel. Communication established via the VELOX Variable Time Communication (VTC) protocol. The VTC allows the VELOX devices to communicate in high communication immunity over a long distance of 2km loop length

Connections

The units can be connected to Velox Fire Alarm Panels as shown in below :

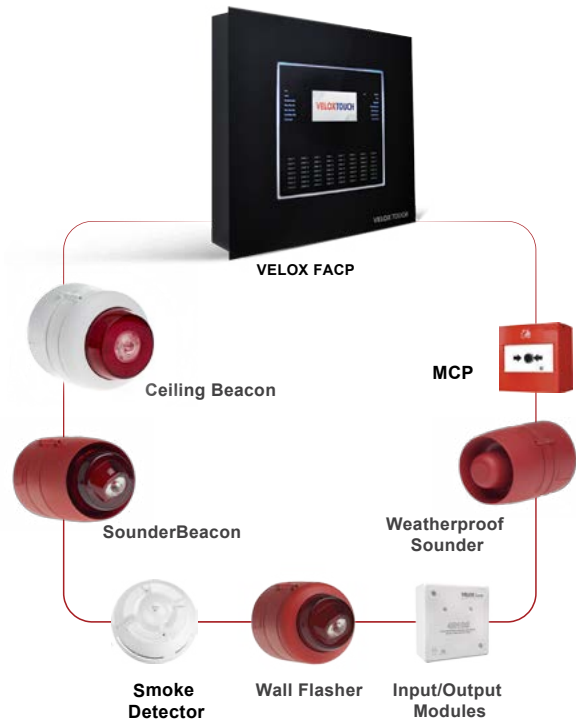

Product Overview & Dimensions

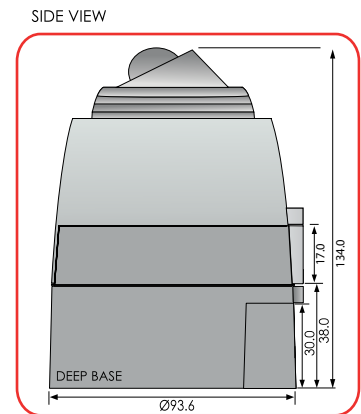
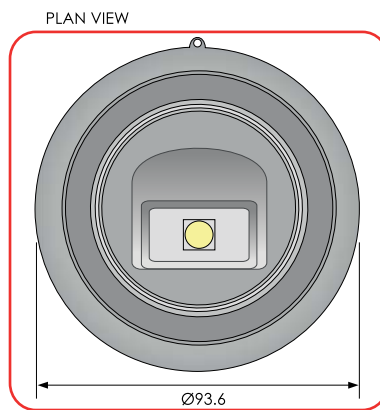









Technical Specifications

voltage range (Vdc)	18 - 30
number of tones	32
operating frequency (Hz)	440 - 2900
temperature range (°C)	-20 to +70
flash rate	1Hz (approved)
Addressing	Automatic or Manual
protection rating (BS EN 60529)	IP65C(deep)
lens colours available/flash colour	white flash
boxed weight (kg)	0.29 kg
body colours available	red (ABS fire retardant plastic)
Fault Protection	Inbuilt Isolator
Max Current (mA) @ 24VDC	8.3 - 30.8

Performance

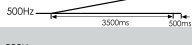
volume setting	high	low
Tone 1 sound output, (dBA)	98	66
max. current consumption @ 24Vdc (mA)	40	25
max power consumption @ 24Vdc (mW)	960	600
Beacon coverage	W-2.4-8 (approved) (option for W-2.4-4 does not comply with EN54-23)	
Light temporal pattern	Single pulse width of 100ms @ frequency of 1Hz (approved)	

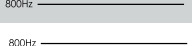
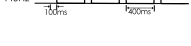
Approved Tone List - Graphical

switch (23456)	no.	name	1st stage frequency	1st stage graphical	2nd stage frequency	2nd stage graphical
11111	1	LF Sweep	800-1000Hz swept every 500ms (2Hz)		800Hz continuous	
11000	8	LF Continuous tone BS5839	800Hz continuous		800Hz continuous	
10101	11	Dutch sweep	970Hz continuous		500-1200Hz for 3500ms, then off for 500ms	
00111	25	German DIN tone	1200-500Hz swept every 1000ms (1Hz)		800Hz continuous	
00101	27	French tone AFNOR	554Hz for 100ms, then 440Hz for 400ms		800Hz continuous	

Order Codes

41320-W-2.4-8	Loop Powered Addressable Wall Mounted Sounder Beacon
41321-W-2.4-8	Loop Powered Addressable Weatherproof Wall Mounted Sounder Beacon

EN54-3 Approved Minimum Sound Output at 1 Meter - Low Volume
Tone 1-

Angle	Horizontal Plane dB(A)		Vertical Plane dB(A)	
	Vmin	Vmax	Vmin	Vmax
15°	67.23	72.31	66.307	71.94
45°	67	72.24	66.02	71.84
75°	75.06	80.21	74.84	79.99
105°	75.45	80.56	75.034	80.29
135°	66.46	72.13	67.44	72.43
165°	67.53	73.09	68.402	73.04

Tone 8 - 800Hz Continuous Tone

Angle	Horizontal Plane dB(A)		Vertical Plane dB(A)	
	Vmin	Vmax	Vmin	Vmax
15°	65.27	70.44	65.375	70.778
45°	65.08	70.45	64.753	70.193
75°	74.81	79.86	74.628	79.837
105°	75.06	80.2	75.377	80.53
135°	66.24	71.3	66.919	72.14
165°	65.99	71.13	66.34	71.732

Tone 11 - Dutch Sweep Tone

Angle	Horizontal Plane dB(A)		Vertical Plane dB(A)	
	Vmin	Vmax	Vmin	Vmax
15°	64.79	70.38	64.189	69.689
45°	67.05	72.6	66.63	72.164
75°	72.56	78.13	72.293	78.226
105°	72.36	77.94	72.236	77.918
135°	67.4	72.84	67.588	72.567
165°	64.04	69.4	64.683	69.633

Tone 25 - German DIN Tone

Angle	Horizontal Plane dB(A)		Vertical Plane dB(A)	
	Vmin	Vmax	Vmin	Vmax
15°	65.84	70.76	66.096	71.373
45°	66.62	71.44	66.808	72.435
75°	74.9	80.1	74.909	80.188
105°	75.16	80.35	75.108	80.296
135°	68.04	73.91	66.672	71.455
165°	67.21	72.75	66.078	71.123

Tone 27 - French AFNOR Tone

Angle	Horizontal Plane dB(A)		Vertical Plane dB(A)	
	Vmin	Vmax	Vmin	Vmax
15°	64.851	70.152	65.446	70.574
45°	65.384	70.652	66.345	71.659
75°	74.374	79.568	74.287	79.466
105°	74.815	80.044	74.74	79.885
135°	66.633	71.953	65.512	70.79
165°	65.633	71.856	65.586	70.809

EN54-3 Approved Polar Diagrams - Low Volume

Tone 1-

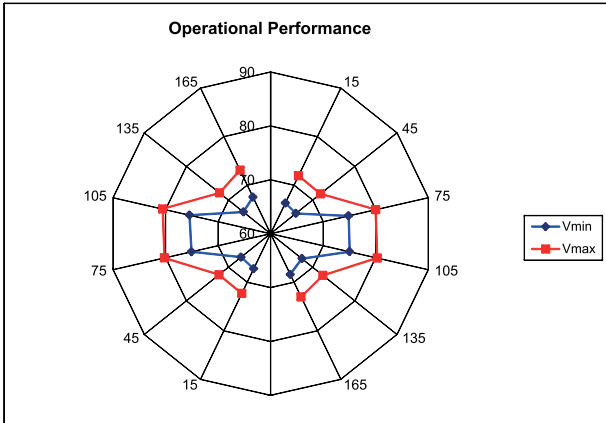

Tone 8 - 800Hz Continuous Tone

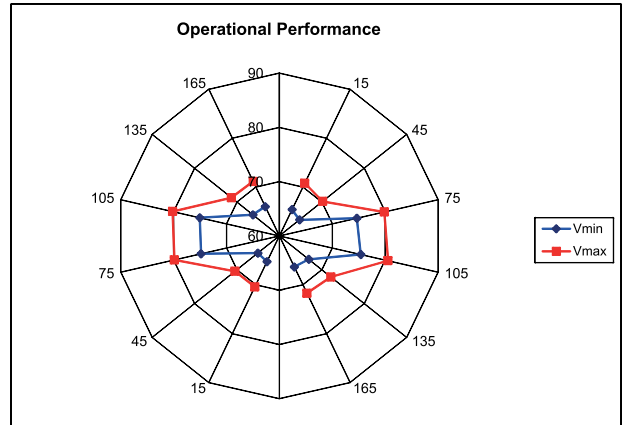

Tone 11- Dutch Sweep Tone

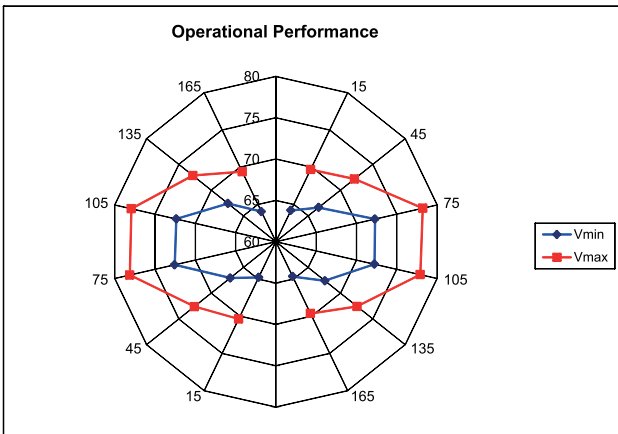

Tone 25 - German DIN Tone

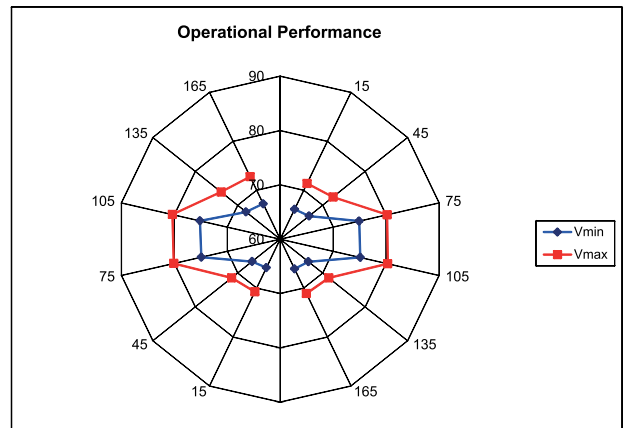

Tone 27 - French AFNOR Tone

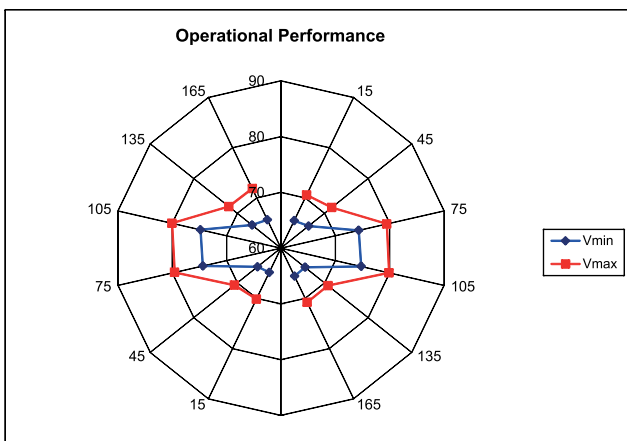

EN54-3 Approved Minimum Sound Output at 1 Meter - High Volume
Tone 1-

Angle	Horizontal Plane dB(A)		Vertical Plane dB(A)	
	Vmin	Vmax	Vmin	Vmax
15°	85.81	90.19	86.027	90.187
45°	86.12	90.44	85.99	90.421
75°	93.95	97.86	93.792	97.68
105°	94.29	98.23	94.073	98.006
135°	86.26	89.97	86.781	90.482
165°	86.86	90.27	87.148	90.716

Tone 8 - 800Hz Continuous Tone

Angle	Horizontal Plane dB(A)		Vertical Plane dB(A)	
	Vmin	Vmax	Vmin	Vmax
15°	84.44	88.58	84.557	88.772
45°	84.74	89.05	84.003	88.371
75°	93.65	97.66	93.331	97.523
105°	93.77	97.76	94.094	98.397
135°	84.73	88.76	86.308	89.952
165°	85.14	89.14	85.856	89.834

Tone 11 - Dutch Sweep Tone

Angle	Horizontal Plane dB(A)		Vertical Plane dB(A)	
	Vmin	Vmax	Vmin	Vmax
15°	84.1	88.02	84.001	88.009
45°	86.36	90.29	86.608	90.615
75°	92.2	96.55	92.566	96.673
105°	92.13	96.46	92.154	96.288
135°	87.28	91.13	86.304	90.417
165°	83.92	87.66	83.191	87.09

Tone 25 - German DIN Tone

Angle	Horizontal Plane dB(A)		Vertical Plane dB(A)	
	Vmin	Vmax	Vmin	Vmax
15°	84.54	89.22	85.44	86.313
45°	85.28	90.34	86.347	90.513
75°	93.73	97.77	93.749	97.762
105°	93.95	97.94	93.867	97.938
135°	87.42	90.63	85.423	89.779
165°	86.62	90.15	84.935	89.147

Tone 27 - French AFNOR Tone

Angle	Horizontal Plane dB(A)		Vertical Plane dB(A)	
	Vmin	Vmax	Vmin	Vmax
15°	83.882	87.869	84.065	87.15
45°	84.874	88.892	85.368	88.477
75°	93.03	96.879	92.758	96.602
105°	93.291	97.227	93.179	97.203
135°	85.4	89.357	84.831	89.456
165°	84.776	88.691	84.429	88.592

EN54-3 Approved Polar Diagrams - High Volume

Tone 1-

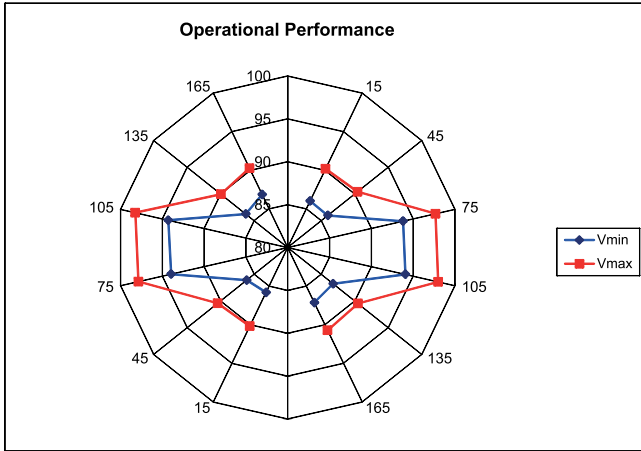

Tone 8 - 800Hz Continuous Tone

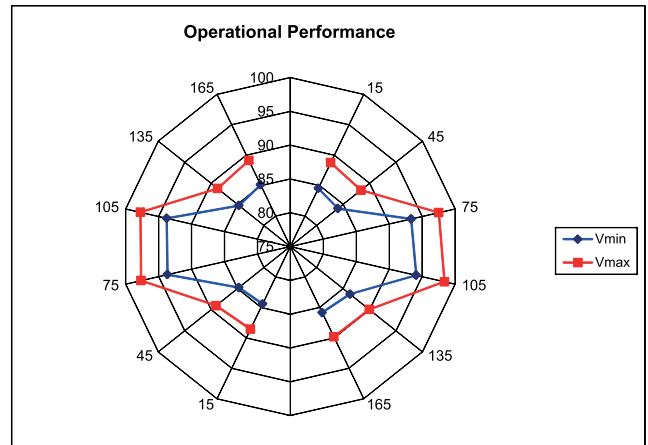

Tone 11- Dutch Sweep Tone

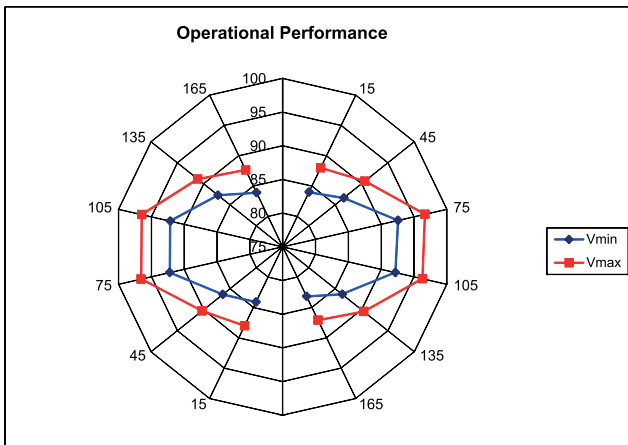

Tone 25 - German DIN Tone

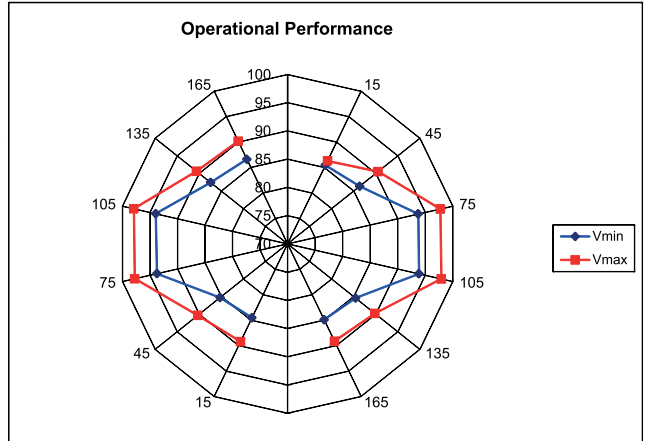

Tone 27 - French AFNOR Tone

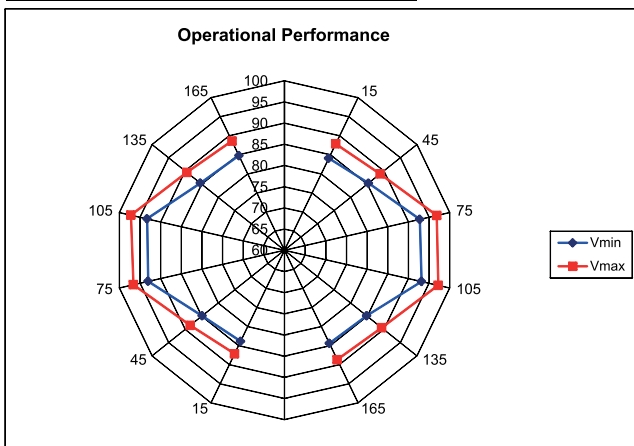

As our policy is one of constant product improvement the right is therefore reserved to modify product specifications without prior notice
 Ref. Velox4132x/S/R1/V1/020719

ATEiS Middle East FZCO.

LIU No.11 Dubai Silicon Oasis
 P.O. Box 293640 Dubai United Arab Emirates.
 Tel. +971 (4) 3262730 - Fax. +971 (4) 3262731
 info@ateis.ae, www.ateis.ae, www.velox.ae